



# Installation Manual

Rev.2.1

## High Resolution 360° Network Camera

Model: **NUD360-F**



### Contents

1. Introduction .....	2
2. Safety Instructions .....	4
3. Installation Requests .....	5
4. Package Contents .....	7
5. Physical Description .....	8
6. Installation of Camera.....	10
7. Other Connections.....	17
8. How to Install / Remove the Memory Card .....	21
9. Connect Camera to Network .....	23
10. Accessing the Camera.....	24

Thank you for purchasing the ZOOM product.

- Please read this manual carefully and use it correctly and safely.
- Please read "Safety Instructions" before use.
- Please keep this manual in a safe place.
- Product operation and setting methods are described in the IP Utility and Web Configurator instructions that are included in the CD-ROM provided with the product.

**Note:** In order to read the PDF file, Adobe Reader of Adobe Systems Corporation is necessary.

# 1. Introduction

---

This is the installation manual for the high resolution 360 ° network camera NUD 360-F.

## Product Summary

This device is a surveillance camera equipped with a 10BASE-T / 100BASE-TX terminal (network terminal) for the network.

By connecting a network such as LAN (Local Area Network) or the Internet to this device, you can check the video and sound of the camera with PC (personal computer) on the network.

**Note:** When checking the camera image on the PC, it is necessary to set the PC's network environment. In addition, please install a web browser for the Internet in advance on the PC.

## Key Features

- Newly designed fringe priority fisheye lens is installed, achieving high resolution in all directions of 360 degree. A great improvement of the resolution of long-distance images that other conventional fisheye cameras were not good at.
- 12.4 Mega pixel color CMOS sensor is implemented. 9 Mega H.264, 18 fps, 4 Mega H.264, 30 fps streaming output is possible.
- The camera body is full of intelligent functions such as motion detection and provides a variety of monitoring methods.
- Equipped with a SD memory card slot, you can save movies and still images.
- Dust-proof and water-proof dome housing conforming to IP66 is adopted.

## About immunity

- This camera was created for the purpose of obtaining images to monitor for a specific area. This camera alone does not prevent crime or the like.
- We do not assume any responsibility with regard to the followings in any case.
  - ① Accidental, special or consequential damages / injuries / harms caused directly or indirectly in relation to this device
  - ② Inconvenience, damage or harm to the device caused by user's misuse or inadvertent failure.
  - ③ Any malfunction or defect of the device, if the disassembling, repairing or remodeling of this device is done by a user, irrespective of whether or not caused by it.
  - ④ Inconvenience, damage, or harm caused by impossibility of displaying images due to any cause or reason including failure / malfunction of this device.
  - ⑤ Malfunction of the device, or inconvenience, damage or harm caused as a result by connecting with third party's equipment.
  - ⑥ Any indemnification claims or complaints due to reasons such as infringement of privacy by individuals or organizations who became subjects as a result of surveillance video (including records) taken by the user being publicized or used.
  - ⑦ The registered information content will be lost due to some reason.
- Every reasonable care has been taken during the writing of this manual. Please inform your local office if you find any inaccuracies or omissions.

- We are not responsible for accidents or damages caused by constructions not described in this manual or instruction manual, or by a method not using specified parts. Also, if a failure occurs due to its construction, it will be out of warranty for the product.
- We will not be held responsible for any typographical or technical errors to the product and manuals and reserves the right to make changes without prior notice.

### **About protection of personal information**

Information that can be identified by the person himself / herself photographed in the system using this camera falls under the "personal information" stipulated in the "Personal Information Protection Law". Please handle image information properly according to the law.

### **About trademark and registered trademark**

- Microsoft, Windows, Windows VISTA, Windows 7, 8, 8.1, 10, Internet Explorer are registered trademarks or trademarks of Microsoft Corporation in the United States and other countries.
- We are using screen photos according to the guidelines of Microsoft Corporation.
- Windows's official name is Microsoft Windows Operating System.
- Adobe, Adobe Reader, Acrobat Reader, and Adobe Active X are registered trademarks or trademarks of Adobe Systems Incorporated in the United States and other countries.
- SD logo, SDHC logo and SDXC logo are trademarks of SD-3C, LLC.
- WiMAX is a trademark of WiMAX Forum.
- Other company names, product names and logos described in this manual are trademarks and registered trademarks of each company.

### **About copyright**

Copying, disassembling, decompiling, reverse engineering, assignment of software included in this product is prohibited. Also, exporting acts in violation of export laws of all software included in this device are forbidden.

### **Networking precautions**

As this device is used by connecting to the network, it is expected to suffer damages as follows.

- ① Information leakage or flow out via this device
- ② Interruption or stop of this device by a malicious third party
- ③ Illegal operation of this device by a malicious third party

In order to prevent such damages, under the responsibility of the user, please fully implement the network security measures including the following measures.

- When using this device on a system to which a PC is connected, check that checks and disinfections against infections of computer viruses and malicious programs are performed at regular intervals.
- Use this device on a secure network using a firewall or the like.
- To protect against unauthorized attacks, set a user name and password and limit the users who can log in.

- Implement countermeasures such as restricting access by user authentication so as not to leak image data, authentication information (user name, password), alarm mail information, FTP server information, DDNS server information etc. on the network.
- Always close all browsers after accessing this device with an administrator.
- Do not install the unit in such a location that the unit, cables etc.

## 2. Safety Instructions

---

### **Cleaning**

Disconnect this device from the power supply before cleaning.

### **Accessories and Repair Parts**

Use only the accessories and repair parts recommended by the manufacturer. Using other attachments not recommended by the manufacturer may cause hazards.

### **Installation**

Install other devices (such as PoE injector, alarm, etc.) that will be used with the camera in a dry place protected from weather.

### **Servicing**

Do not attempt to service this device yourself. Refer all servicing to qualified service personnel.

### **Damage Requiring service**

Disconnect this device from the power supply immediately and refer servicing to qualified service personnel under the following conditions.

### **When the power-supply cord or plug is damaged**

If liquid has been spilled, or objects have fallen into the device.

If the inner parts of device have been directly exposed to rain or water.

If the device does not operate normally even by following the operating instructions in this manual. Adjust only those controls that are covered by the instruction manual, as improper adjustment of other controls may result in damage, and will often require extensive work by a qualified technician to restore the device to its normal operation.

### **Safety Check**

Upon completion of any service or repairs to this device, ask the service technician to perform safety checks to determine if the device is in proper operating condition.

## 3. Installation Requests

---

### About Power Supply

- This unit does not have a power switch.  
To turn off the power to the camera, turn off the PoE power supply device.
- During the installation, please ensure to make it possible to turn on / off the camera power. Be sure to turn off the power to the camera when cleaning or maintenance.

### About the installation place of the camera

Please consult well with the dealer you purchased or the specialized installation contractor about the place to install the camera. Please choose well durable walls or ceiling etc.

- Please install it on a ceiling (concrete ceiling etc.) or fittings with sufficient strength.
- Please install in the base part of the building or the part with sufficient strength.
- Please do not install on a gypsum board or wooden portion because strength is weak.  
When installing it unavoidably, please provide sufficient reinforcement.
- Keep the lens out of direct sunlight.

### Installation and use in the following places is not allowed

Although this unit meets IP66 waterproof specifications, internal electronic components may be damaged under the following circumstances, and it can not be guaranteed.

- Where to use drugs such as pools
- Places where special environments such as solvents and flammable atmospheres occur
- Where radiation, X-rays, and powerful radio waves and magnetic fields occur
- Places where corrosive gases are generated at sea or coastal streets, in salt-containing environments
- Location beyond the operating temperature range
- Places subject to vibration
- About installation of low temperature environment

The camera can be used even in low-temperature outdoor environments up to -20 ° C, but in severe environments below -10 ° C, snow and frost adhering to the camera may not be thawed.

When installing and starting up in an environment of -10 ° C or lower, normal images may not be obtained immediately after startup. In this case, please wait for about 2 hours after turning the power on, turn off the power and turn on the power again.

### About installation of the camera

Please note the following points when installing.

- Anchors, screws, bolts and nuts to be used when installing the camera to a ceiling or wall are not included. Please use the reliable ones according to the structure and material of the installation place.
- Tighten firmly according to the material and structure of the installation place, based on installing with bolts and nuts.

- Do not use the impact screwdriver to tighten the screws. It may cause screws to be damaged.
- Tighten the screw straight. After tightening, please visually confirm that it is firmly tightened without rattling.
- Do not loosen or remove the screws on the outside of the camera. It may cause damage due to immersion and fall accidents. Also, please tighten firmly even when loosen.

### About care and maintenance

In order to use the device safely and correctly, please do routine maintenance and periodic inspection by dealers or contractors.

- If the lens cover becomes dirty, wipe gently with a soft cloth impregnated with a mild detergent. In that case, please do not rub the lens cover strongly or wipe with the solvent.
- When using the projector at a high altitude, in order to prevent injuries and accidents caused by falling, check the following conditions on a daily basis.

<ul style="list-style-type: none"> <li>● The device is left without using.</li> </ul>	⇒	<p>To prevent accidents, be sure to ask dealers or contractors to remove it.</p>
<ul style="list-style-type: none"> <li>● The installation screws are loose or missing.</li> <li>● The installation place is loose or inclined.</li> <li>● There are damaged or marked rust in the device or the installation place.</li> </ul>	⇒	<p>To prevent accidents, be sure to ask dealers or contractors to repair it if necessary.</p>

- When using beyond 8 years, please consider the replacement as well as increasing the number of periodic inspections.
- If you are using the device for many years, there may be a possibility that the parts may be deteriorated depending on the use environment and leading to breakdown or accident, even if there is no abnormality on the appearance. Please check the following situation on a daily basis.

Please **immediately stop using the device** in the following situation. Please turn off the power and ask the dealer or contractor to inspect, repair or remove in order to prevent breakdown or accident.



- ◆ Smoke, smells and abnormal sounds come out.
- ◆ The PoE, its power cord and power plug are abnormally hot. Or there are cracks and scratches.
- ◆ If you feel bilberries and electricity by touching the device.
- ◆ Even when you turn on the power, no image or sound comes up.
- ◆ Other abnormalities or malfunctions.



Always ask the dealer or a special contractor for construction. Failure to do so could result in fire, electric shock, injury, damage to the equipment.

## 4. Package Contents

Check if the camera package comes with the following items.

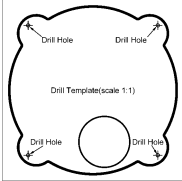
Camera	Cable Gland	Conduit Gland
		
Terminal Block (for DI/DO)	Terminal Block (for Audio In/Out)	Hexagon Screwdriver
		
Application CD	Quick Installation Guide	Drill Template
		

**IMPORTANT:** When the camera is taken out from the box, the lens cover is covered by a plastic thin film. To avoid scratches or leaving fingerprints on the lens cover, it is recommended to retain the film covering the lens cover until the camera is completely installed and all connections are completed. However, the plastic has been removed on some of the pictures in this documentation to show clarity of the procedures being described.

# 5. Physical Description

## NUD360-F

<Appearance>

<Bottom View>

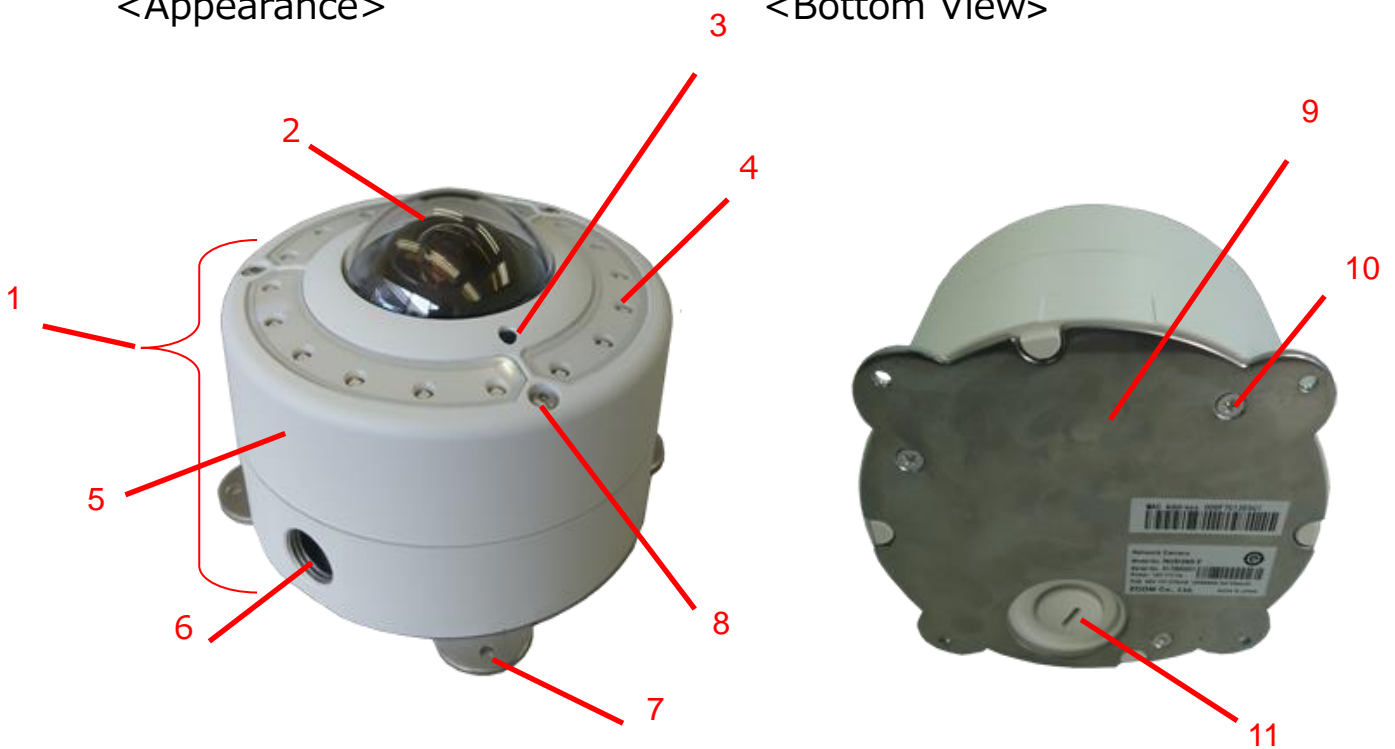

Item	Description
<b>1</b> Body	IP66, water-proof, particle-proof, aluminum die-cast
<b>2</b> Lens Cover	Protects the lens. (Initially, this is covered by a thin film.)
<b>3</b> Light Sensor	Detects a light volume for switching day/night mode.
<b>4</b> IR LED	18 pcs of IR lights. (invisible wave length)
<b>5</b> Top Case	Aluminum die-cast
<b>6</b> Cable Hole (side)	Be used when pulling the cable out from the side. When shipped, a black plastic cap is inserted for dustproofing.
<b>7</b> Installation Screw Hole	Using these holes (x4), install the camera.
<b>8</b> Top Case Screw (x3)	Fix Top Case to Bottom Case. Its head has a special shape. Use the included Hexagon Screwdriver.
<b>9</b> Installation Plate	When installing the camera, fix this plate.
<b>10</b> Camera Fixing Screw	Be fixing Installation Plate to Body. Never loosen or remove these.
<b>11</b> Cable Hole (bottom) and Cable Hole Cap	Together with the waterproof ring, please attach either to the side hole or the bottom hole, on the side not using. (It is attached to the bottom at the time of shipment.)



<Inside View>

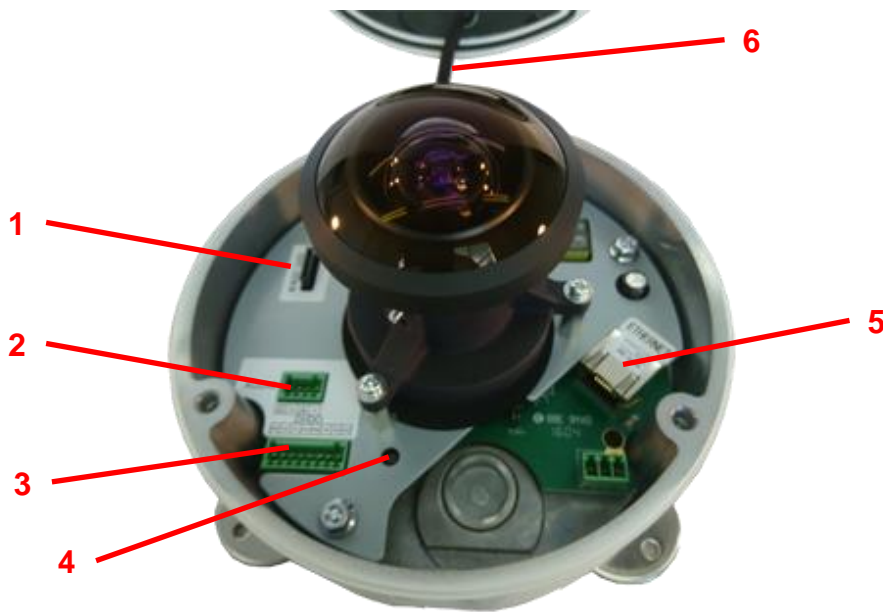

	Item	Description
1	Memory Card Slot	Insert a memory card (not included) into the slot for local recording purposes. Refer to the page 21 "Install the Memory Card". <b>Note:</b> Supports only MicroSDHC and MicroSDXC cards.
2	Audio Input / Output	Connects to audio input and output devices, such as microphones and speakers.
3	Digital Input / Output	Connects to digital input or output devices, such as an alarm trigger, panic button, etc. Digital Input (DI) / Digital Output (DO) devices are used in applications like motion detection, event triggering, alarm notifications, etc.
4	Reset Button	Restores the factory default settings of the camera. To reset the camera, while the power is on, press and hold Reset Button for at least 5 seconds.
5	Ethernet Port	Connects to a network using an Ethernet cable.
6	Fall Prevention Wire	Being connected to Body, this prevents Top Case from falling when Top Case is removed.

## 6. Installation of Camera

Follow the steps below to install the camera.

**Note:** When installing, select a sufficiently strong wall or ceiling surface with consulting with your purchased dealer or the special installation contractor frequently.

**Note:** Please carefully read "Safety Instructions" and "Installation Requests" and handle them.

### Step 1: Decide how to route the cable

Before drilling the holes on the ceiling or wall, please check the cable pullout position.

Depending on how the cables will go along the ceiling or wall, decide whether to put the cable out from the side of the camera or from the bottom.

If you want the cable to go along the surface of the installation place, take out the cable from the side of the camera.

When routing the cable inside of the installation place by penetrating the installation surface, take out the cable from the bottom of the camera.

**Note:** There is only one Cable Hole Cap attached on the camera. Please attach it to either side or bottom cable hole which does not use.



<Examples using a cable gland.>



### Step 2: Drill holes for installation in the installation place

1. In accordance with the direction of the camera, place the included "Drill Template" to the installation place.
2. Drill 4 Screw Holes printed on the Drill Template.
  - ※ If pulling the cable out from the bottom of the camera, also drill out the Cable Hole.
  - ※ Depending on the material and conditions of installation place, it is necessary to embed plastic or metal cap or anchor in the screw hole. It is good to embed it at this stage.

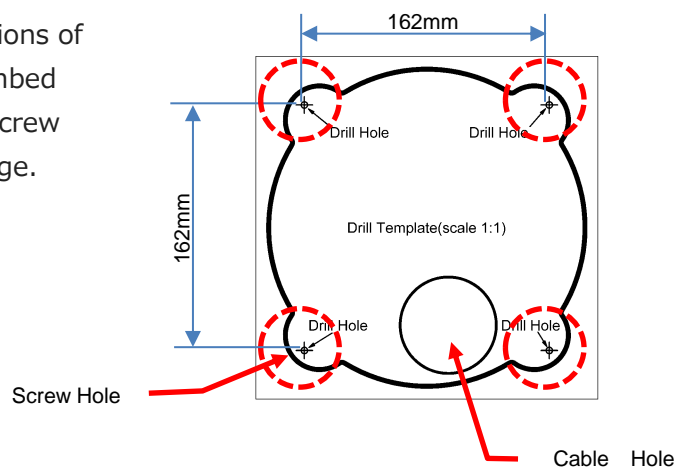

### Step 3: Open the Top Case

1. With the bundled Hexagon Screwdriver, loosen the three Top Case Screws.
  - ※ The shape of the head of Top Case Screw is special. Please use the attached Hexagon Screwdriver.



The top case is heavy, so please handle it carefully.

- ※ Do not abruptly lift the cover; the Fall Prevention Wire is connected on the camera body and the Top Case. Please place the Top Case next to the camera.
- ※ To avoid scratches or leaving fingerprints on the lens cover, it is recommended to retain the plastic thin film covering the lens cover until the camera is completely installed and connections are completed. However, the plastic has been removed on some of the pictures in this documentation to show clarity of the procedures being described.

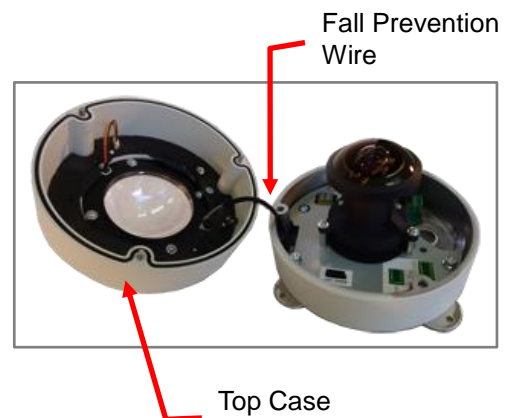

2. If necessary, insert a memory card, with the metallic contacts facing down, into the card slot of the camera. See How to Install / Remove the Memory Card on page 21.





### Step 4: Prepare to Waterproof

When it is necessary to waterproof the cable and cable pulled out portion, please decide the waterproofing method in advance.

The camera comes with two (2) glands used for waterproof installation:

- **Cable Gland:** For use with an **Exterior-grade Ethernet cable**. Exterior-grade Ethernet cables are already waterproof. See **Waterproof Solution with Naked Cable** on page 13.
- **Conduit Gland:** For use with a flexible conduit. This solution is recommended when an exterior-grade Ethernet cable is not available or other cables, such as power adapter, DI/DO devices, etc. will be connected with the camera. See **Waterproof Solution with Condit** on page 13.

Determine the type of waterproof solution that is applicable to your installation requirements and prepare the necessary accessories or purchase extra materials.

Cable Gland	Conduit Gland
 <p>For use with an <b>Exterior-grade Ethernet cable</b> (not included in the package).</p> 	 <p>For use with 1/2" flexible conduit (not included in the package)</p> 

### Waterproof Solution with Naked Cable

This section describes the procedures to waterproof the cabling connections using an exterior-grade Ethernet cable.

1. Disassemble the cable gland as shown below:



2. Insert the clamping nut into the Ethernet cable.



3. Insert the sealing insert with claw.

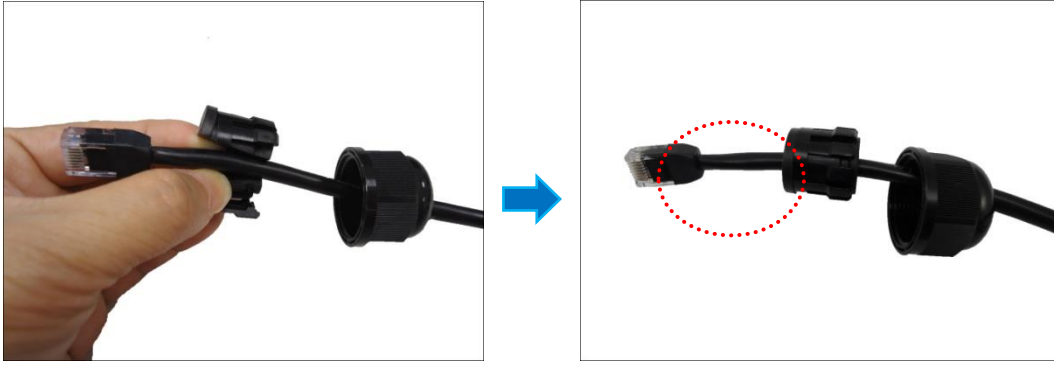

### Waterproof Solution with Conduit

This section describes the procedures to waterproof the cabling connections using a flexible conduit with 1/2" trade size (not supplied). This is the recommended solution when connecting an external power adapter, audio in/out, or digital input/output (DI/DO) devices to the camera.

1. Disassemble the cable gland as shown below:

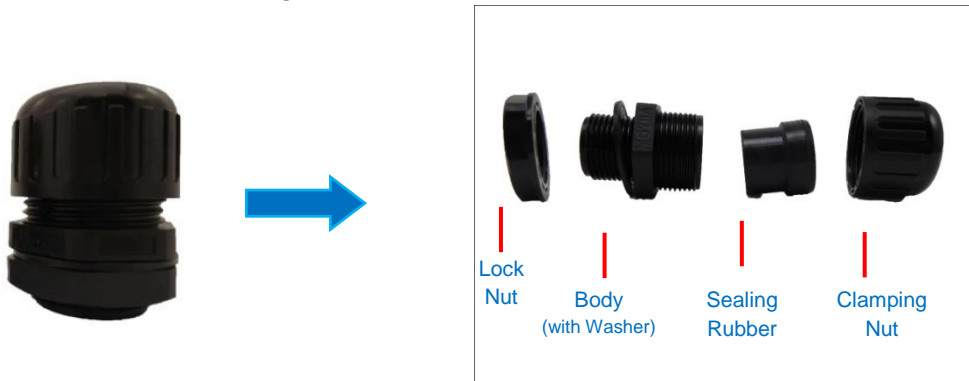

**Note:** In this installation, the conduit gland body can be securely attached to the camera, therefore the use of **lock nut is not necessary**. Please set the lock nut aside.

2. Pull the Ethernet cable and other cables (if any) through the flex conduit.

**Note:** To connect an external power adapter, audio in/out, or digital input/output (DI/DO) devices, insert the cables without connectors through the flex conduit together with the Ethernet cable at this point.

3. Insert the clamping nut through the flex conduit.
4. Insert the sealing rubber and attach it at the end of the flex conduit.

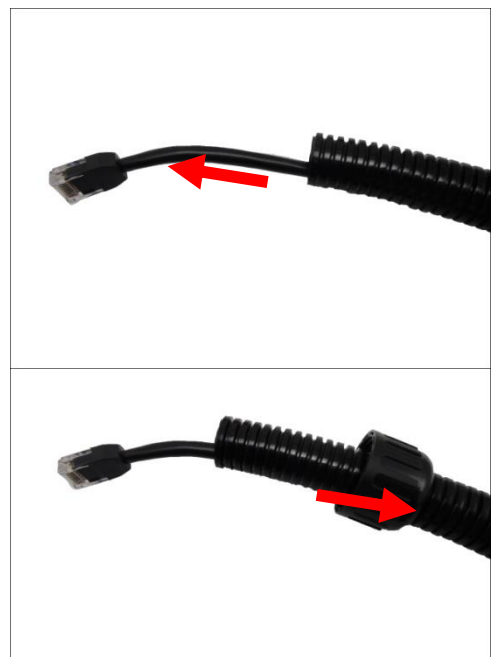

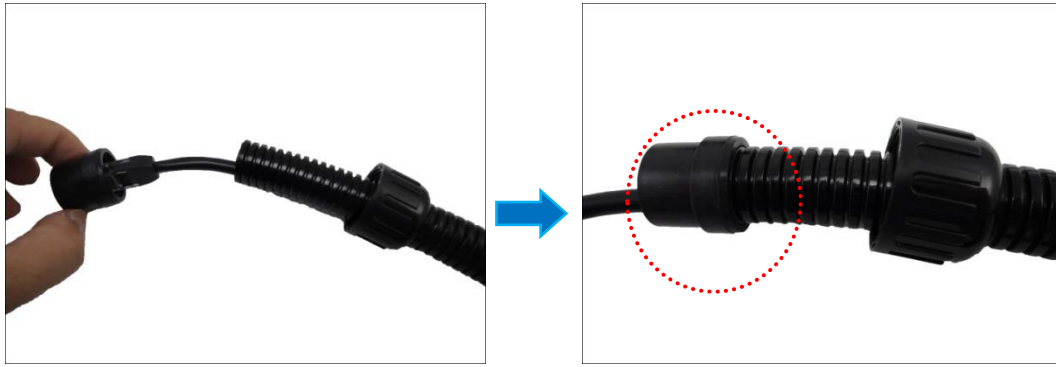

### Step 5: Connect the Cables

Connect the cables drawn from the Cable Hole (side or bottom) to the specified connector.

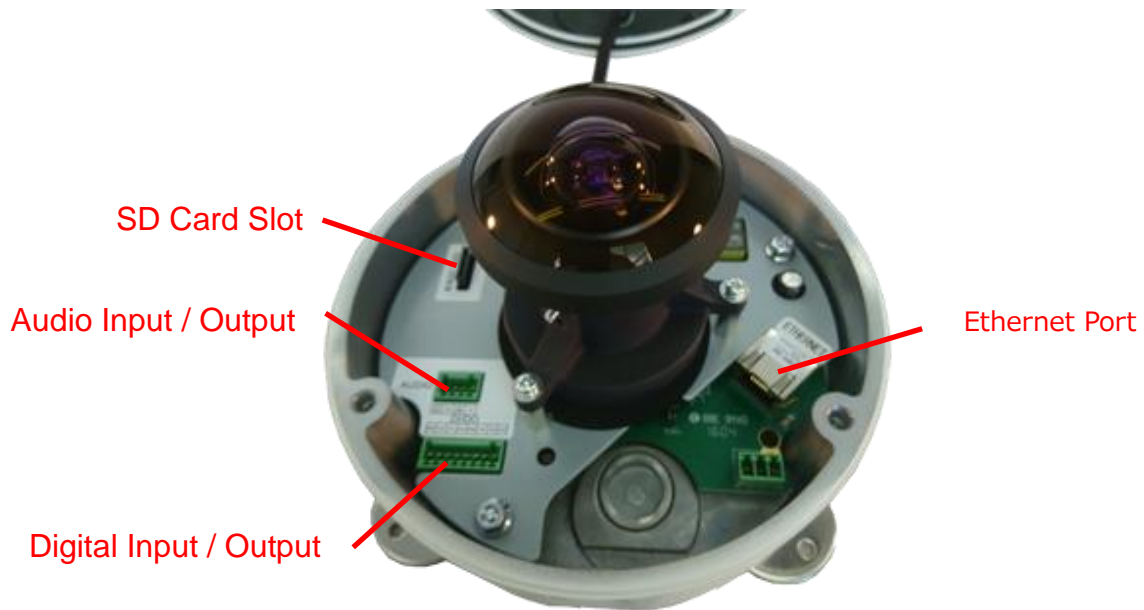

### Step 6: Assemble the Top Case

Return the top case to its original position and tighten the Top Case Screws (3 places).



At that time, please do not pinch the Fall Prevention Wire and cables.



## Step 7: Install the Camera to the Surface

Before installing the camera to the installation place, the camera must have the following preparations completed.

- ① Cable withdrawal was completed.
- ② Waterproofing of the cable and the Cable Hole and so on were completed.
- ③ Memory card installation was completed.

1. According to the above described Steps 1 to 4, complete the above ①~③.
2. Attach the camera to the installation surface using the four Installation Screw Holes on the Installation Plate. (Right figure, red circle)



- ※ In order to prevent a possibility of invasion of rain, it is recommended to install at the angle where the Cable Hole faces downward.
- ※ Do not loosen or remove the Camera Fixing Screw (right figure, 3 yellow squares) that fixes the camera to the Installation Plate.
- ※ Please use screws for installation that match the material of the installation place.
- ※ Because the camera is heavy, fixing should be based on the bolt & nut tightening.

**Disclaimer:** *The manufacturer will not be responsible for camera damage caused by improper installations or the misuse of equipment for installation.*

**The basic installation of the camera is completed with the above.**

**Issues which are not mentioned up to this point, such as the connections of external power supply, audio input / output, digital input / output and the installation of memory card will be explained in the subsequent chapters. Please refer as necessary.**

**For the connection to the network, refer to the page 23 or later.**

## Point of Attention:

# In case of Corner Mounting with 270° panorama view

When the camera is installed facing down at the corner of a building and the entire image other than the building (90 °) is shown in the 270 ° panorama view (Refer to the Software User's Manual P.41) , the 90 ° part of the fisheye image must be at the building side.

Install the camera with its side cable outlet faces the opposite direction of the corner of the building.

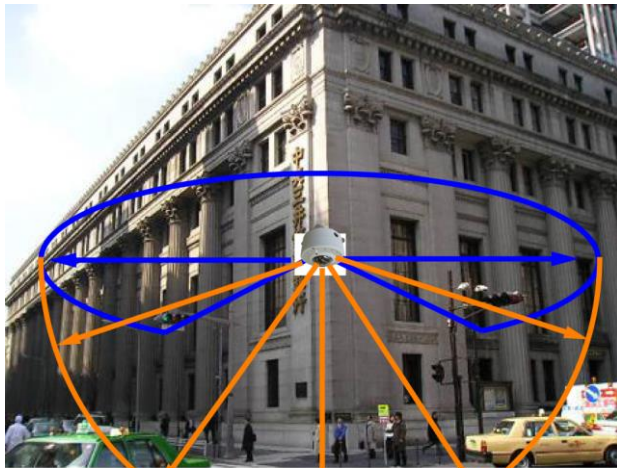

【 Top View 】



Dewarped in one 270° panorama view

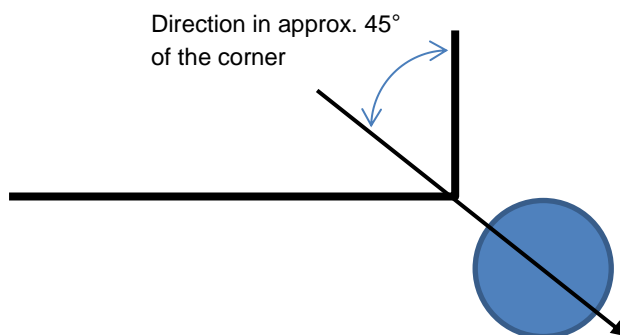

The side cable outlet faces the opposite direction of the corner of the building.



## 7. Other Connections

This section describes the procedures in preparing the external devices that you can connect to the camera. The camera supports DC12V power input, Digital Input and Output (DI/DO) and Audio Input and Output devices using the bundled terminal blocks. The use of these devices, however, is optional.

### 7-1. Connecting DI/DO Devices (Optional)

Depending on your surveillance needs, you may connect digital input or output devices to your camera to trigger events or notifications.

Digital Input (DI) devices can be used to notify the camera about an activity in the camera site. DI can be triggers of events. For example, you can connect a “panic button” to the camera; as such when the panic button is pressed, the alarm signal will be sent through the camera. Other common DI device applications are emergency button, smoke detector, passive infrared sensor, etc.

Digital Output (DO) devices are external devices that are activated by the camera upon an event inside the camera. For example, you can connect an “alarm horn” to the camera; as such when an event occurs inside the camera (e.g. detected intruder), the alarm horn will sound. Other common DO device applications are motion-triggered lights, electric fence, magnetic door locks, etc.

You can connect up to two DI and two DO devices to your camera. Press and hold the orange tab as you insert the wire through the pin slot, then release the orange tab to secure the wire.



To connect input devices (DI), map the pins to one of the pin combinations below:

Device	Pin	Mapping Instructions
Digital Input 1 (DI1)	GND	Connect the wires of the first input device to <b>GND</b> and <b>DI1</b> .
	DI1	
Digital Input 2 (DI2)	GND	Connect the wires of the second input device to <b>GND</b> and <b>DI2</b> .
	DI2	

To connect output devices (DO), map the pins to one of the pin combinations below:

Device	Pin	Mapping Instructions
Digital Output 1 (DO1)	12V	Connect the wires of the first output device to <b>12V</b> and <b>DO1</b> .
	DO1	
Digital Output 2 (DO2)	12V	Connect the wires of the second output device to <b>12V</b> and <b>DO2</b> .
	DO2	

The table below shows the DI/DO connection specifications:

Device			
DI	Connection design		TTL - compatible logic levels
	Voltage	To trigger (low)	Logic level 0: 0V ~ 0.4V
		Normal (high)	Logic level 1: 3.1V ~ 30V
	Current		10mA ~ 100mA
DO	Connection design		Transistor (Open Collector)
	Voltage & Current		< 24V DC, < 50mA

### Typical Connection:

Based on these specifications, if the DI device has a voltage of 0V ~ 30V or the DO device has a voltage of < 24V (<50mA), then the camera can supply internal power to these devices and there is no need to connect the DI/DO device to an external power source.

In this case, wire connection to **GND** and **DI1** pins to connect a DI device and use the **12V** and **DO1** pins to connect a DO device. See wiring scheme below:

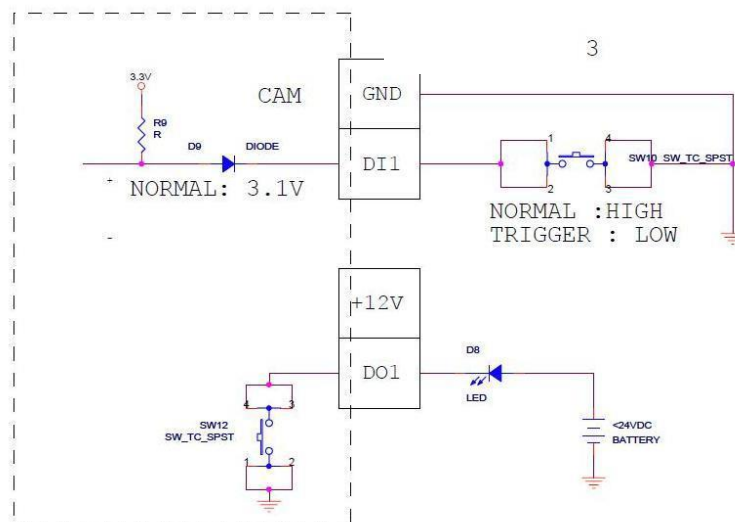

Consequently, wire the connection to **GND** and **DI2** to connect a second DI or to **12V** and **DO2** to connect a second DO device.

## High Voltage DO Device Connection

Even though the camera provides 12V power, this may not be enough for some high voltage DO devices, such as a ceiling light or a motor that opens or closes a gate. In this case, there is a need to connect an external relay. See wiring scheme below:

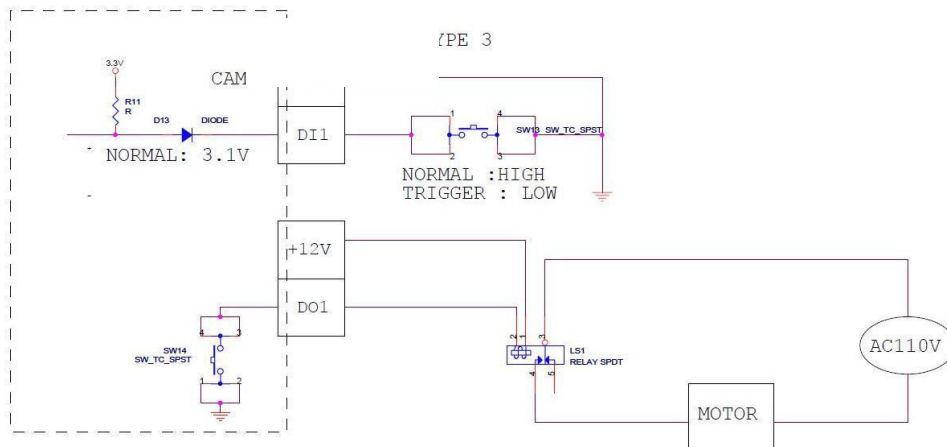

Note that when choosing an appropriate relay, please refer to its specifications and make sure they match the above design. The triggering circuit voltage has to be around 12V DC and the switch-controlled circuit voltage has to match the external power supply (e.g. 110V AC or 220V AC).

The illustration below is a graphic example of connecting a relay to a high voltage DO device.

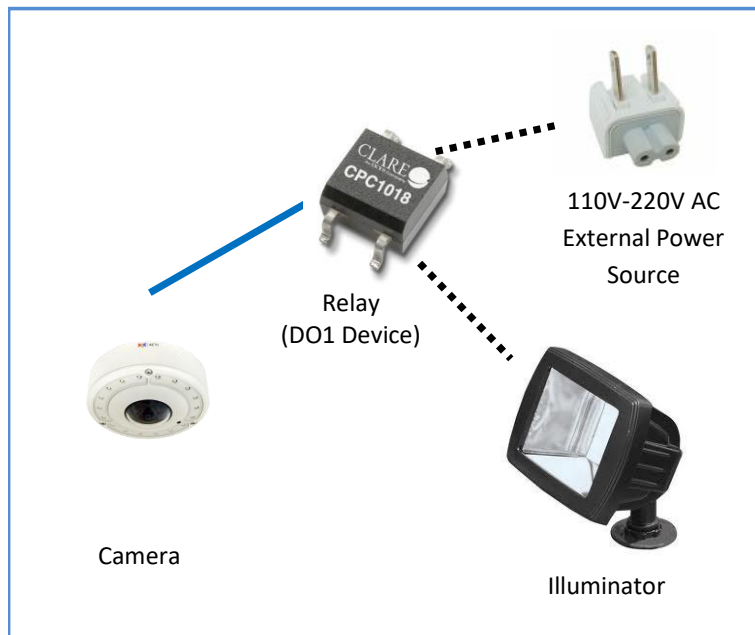

## 7-2. Connecting Audio In / Out Devices (Optional)

Depending on your surveillance needs, you may connect audio input or output device, such as an active microphone or speaker, to your camera. In this case, you need to connect the audio input/output device to the supplied audio terminal block.



To connect audio input / output devices, map the pins to one of the pin combinations below:

Device	Pin	Mapping Instructions
Audio Output	GND	Connect the wires of the audio output device to <b>GND</b> and <b>AUDIO.OUT</b> .
	AUDIO.OUT	
Audio Input	GND	Connect the wires of the audio input device to <b>GND</b> and <b>AUDIO.IN</b> .
	AUDIO.IN	

Press and hold the orange tab as you insert the wire through the pin slot, then release the orange tab to secure the wire.

## 8. How to Install / Remove the Memory Card

The camera supports local video recording to a memory card (not supplied).

**Note:** Camera supports MicroSDHC and MicroSDXC cards.

### Supported storage format:

Local Storage Type	Storage Capacity	Speed Class					
		2	4	6	10	U1	U3
MicroSDHC	4GB - 32GB	Y*	Y*	Y*	Y	Y	Y
MicroSDXC	64GB - 2048GB						

\* Compatible, but not recommended due to lower speed

### Examples of compatible memory cards:



It is recommended to use at least **Class 10**, as it has sufficient recording speed.



If the biggest possible storage size is required, then please use **MicroSDXC with maximum available size in the market.**

### 8-1. How to Insert the Memory Card

1. Open the Top Case. (Refer to the page 11 Step 3)
2. Insert the memory card with the metal contacts facing toward the side which has “MEMORY CARD” sign.
3. Push the card into place down until it is locked.

**Note:** Although it is designed not to be inserted in the opposite direction, please do not force it in.

4. Close the Top Case.
5. Once inserted, make sure to access the camera Web Configurator and “**Mount**” the card to prepare the card for local recording. Refer to the camera Software User’s Manual for more information.

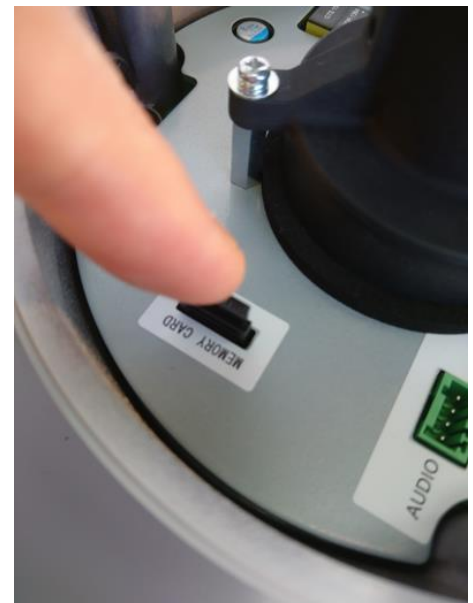

### 8-2. How to Remove the Memory Card

In case there is a need to remove the card, make sure to access the camera Web Configurator to safely “**unmount**” the card first (see the camera Software User’s Manual for more information). Once unmounted from the software, pull the card out from the slot.

### 8-3. Format the Memory Card

The local storage capability will have the **[+] Local Storage** item shown in the “Setup Page” of Web Configurator when the MicroSDHC card has been inserted into the Memory Card Slot of the camera. Select “**Utilities**”, to prepare the storage.

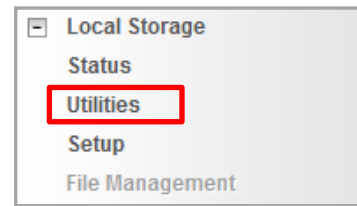

When the Mount storage media button shows “Mount” button then it means that the mass storage has been inserted to the camera, but **the connection between camera and the storage has not been established yet**. By pressing the “**Mount**” button, **the storage becomes active**. It is then possible to check the Status of the disk, write or read data on the disk, remotely access the storage by Web Configurator or FTP client, etc.

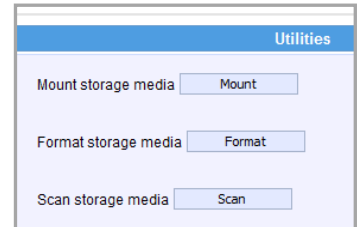

If mounting of the memory card fails, it means that the file system of the memory card is different from camera – in such case, press “**Format**” button to convert MicroSDHC card into compatible file system. It might take couple of minutes to format the storage. It may be needed when using brand new MicroSDHC cards or the ones that have been used in other devices before, such as photo cameras or mobile phones.

If the formatting of the memory card fails, then the card is either physically damaged or does not comply with the specification of the camera. In such case, please use another card.

Once the drive has been mounted, it can later be unmounted by pressing “**Unmount**” button, if necessary. The Unmount function is used when the camera is to be shut down for maintenance or when the mass storage has to be physically removed for some reason. The purpose of unmounting is to protect the currently processed data on mass storage at the moment of removal of the storage. If the local storage is being used by camera and some videos or snapshots are being recorded to the disk, then the sudden shutdown or removal of the disk without unmounting may corrupt the file that currently being used by the camera. The rest of the files are not influenced in any way. Please note that “Save&Reboot” function of the camera also does unmounting automatically for the user.

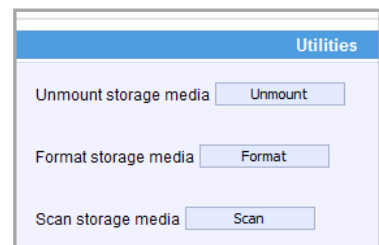

When the storage has been properly mounted to the camera, the “**File Management**” page would become accessible - it is no longer grayed out. You can later use “File Management” to search, download or delete the recordings. At first, the “File Management” page would be empty since there are no files to manage yet. Therefore, you may skip that page for now.

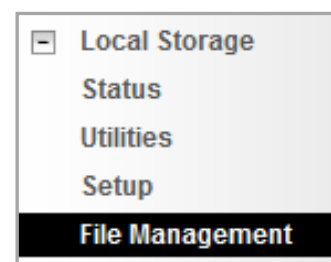

The storage is now ready to save the recordings. It is now time to configure the recording rules. For more details about storage preparation, please refer to the firmware manual.

## 9. Connect Camera to Network

Connect the other end of the network cable to a switch or injector. Then, connect the switch or injector to a network or PC and a power source. See Power-over-Ethernet (PoE) example connection diagram below.

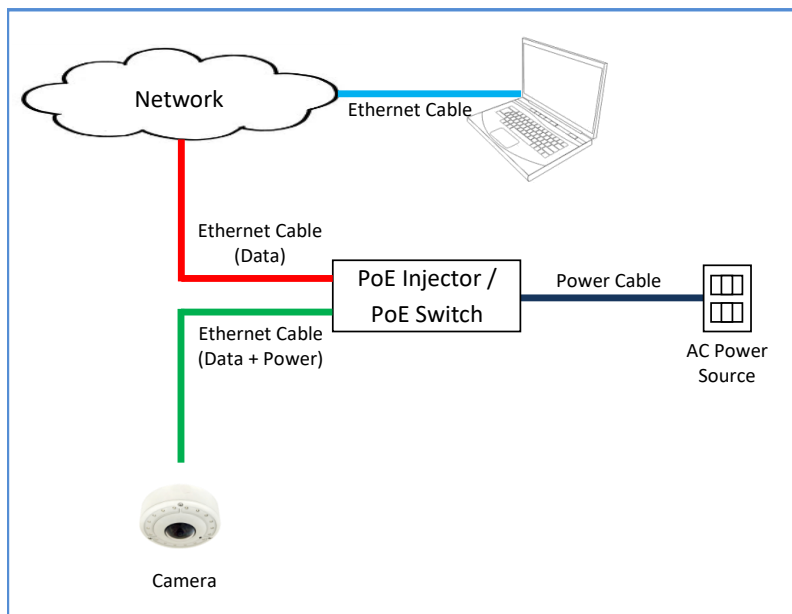

# 10. Accessing the Camera

## 10-1. Configure the IP Addresses

In order to be able to communicate with the camera from your PC, both the camera and the PC have to be within the same network segment. In most cases, it means that they both should have very similar IP addresses, where only the last number of the IP address is different from each other. There are 2 different approaches to IP Address management in Local Area Networks – by DHCP Server or Manually.

### Using DHCP server to assign IP addresses

If you have connected the computer and the camera into the network that has a DHCP server running, then you do not need to configure the IP addresses at all – both the camera and the PC would request a unique IP address from the DHCP server automatically. In such case, the camera will immediately be ready for the access from the PC. The user, however, might not know the IP address of the camera yet. It is necessary to know the IP address of the camera in order to access it using a Web browser.

**The quickest way to discover the cameras in the network** is to use the simplest network search, built in the Windows system – just by pressing the “Network” icon, all the cameras of the local area network will be discovered by Windows, thanks to the UPnP function support of our cameras.

In the example below, the camera that has just been connected to the network is successfully found.

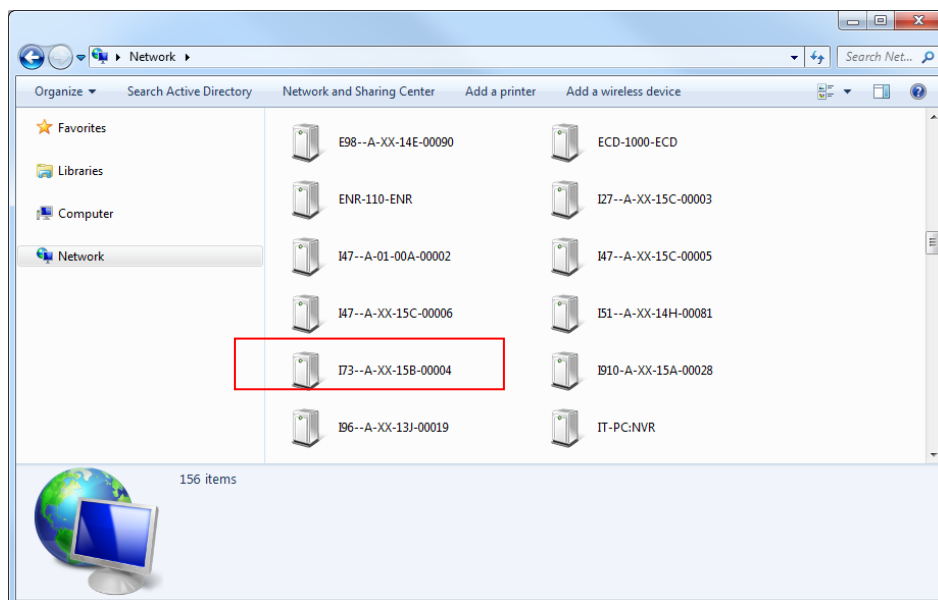

Double-click the mouse on the camera model name, the default browser of the PC is automatically launched and the IP address of the target camera is already filled in the address bar of the browser.



If you work with our cameras regularly, then **there is even a better way to discover the cameras in the network** – by using **IP Utility**. The IP Utility is a light software tool that can not only discover the cameras, but also list lots of valuable information, such as IP and MAC addresses, serial numbers, firmware versions, etc, and allows quick configuration of multiple devices at the same time.

Search and download IP Utility for free in our website.

When you launch IP Utility, the list of connected cameras in the network will be shown. See sample illustration below:

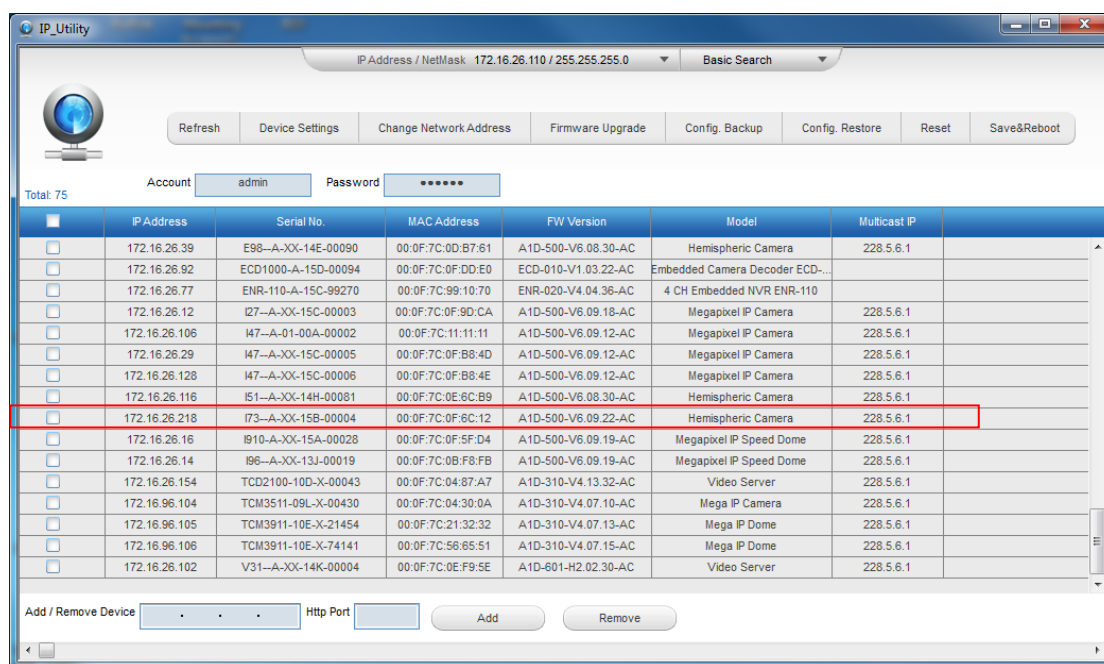

You can quickly notice the camera model in the list. Click on the IP address to automatically launch the default browser of the PC with the IP address of the target camera already filled in the address bar of the browser.

### Use the default IP address of the camera

If there is no DHCP server in the given network, the user may have to manually assign the IP addresses to both the PC and the camera to make sure they are in the same network segment.

When the camera is plugged into the network and it does not detect any DHCP services, it will automatically assign itself a default IP:

**192.168.0.100**

Whereas the default port number would be **80**. In order to access that camera, the IP address of the PC has to be configured to match the network segment of the camera.

## Manually adjust the IP address of the PC

In the following example, based on Windows 7, we will configure the IP address to **192.168.0.99** and set Subnet Mask to **255.255.255.0** by using the steps below:

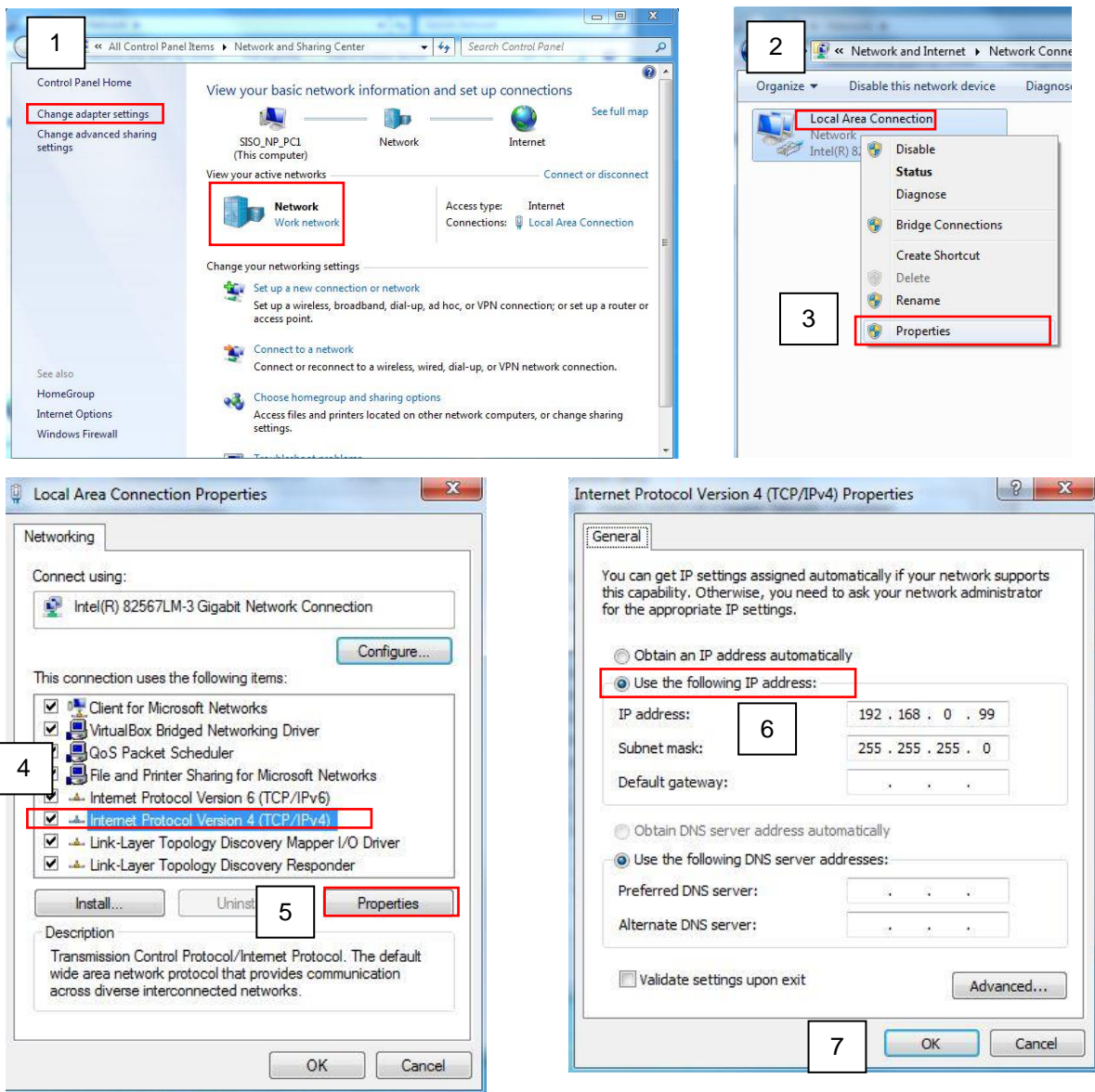

## Manually adjust the IP addresses of multiple cameras

If there are more than one camera to be used in the same local area network and there is no DHCP server to assign unique IP addresses to each of them, all of the cameras would then have the initial IP address of **192.168.0.100**, which is not a proper situation for network devices – all the IP addresses have to be different from each other. The easiest way to assign cameras the IP addresses is by using **IP Utility**:

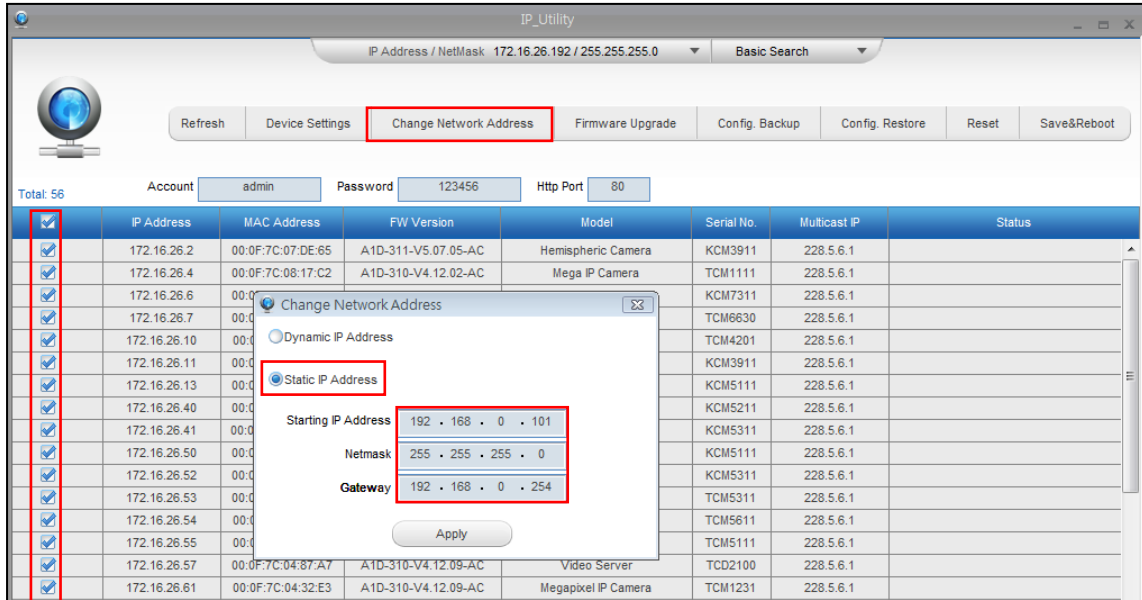

With the procedure shown above, all the cameras will have unique IP addresses, starting from 192.168.0.101. In case there are 20 cameras selected, the last one of the cameras would have the IP 192.168.0.120.

Later, by pressing the “Refresh” button of the IP Utility, you will be able to see the list of cameras with their new IP addresses.



Please note that it is also possible to change the IP addresses manually by using the Web browser. In such case, please plug in only one camera at a time, and change its IP address by using the Web browser before plugging in the next one. This way, the Web browser will not be confused about two devices having the same IP address at the same time.

## 10-2. Access the Camera

Now that the camera and the PC are both having their unique IP addresses and are under the same network segment, it is possible to use the Web browser of the PC to access the camera.

You can use **Microsoft Internet Explorer** as a browser to access the camera.

The browser functionality:

Functionality	Internet Explorer
Live Video	Yes
Live Video Area Resizable	Yes
PTZ Control	Yes
Capture the snapshot	Yes
Video overlay based configuration (Motion Detection regions, Privacy Mask regions)	Yes
All the other configurations	Yes

When using Internet Explorer browser, the ActiveX control for video stream management will be downloaded from the camera directly – the user just has to accept the use of such control when prompted so. No other third party utilities are required to be installed in such case.

**The examples in this manual are based on Internet Explorer browser in order to cover all functions of the camera.**

Assuming that the camera's IP address is **192.168.0.100**, you can access it by opening the Web browser and typing the following address into Web browser's address bar:

**http://192.168.0.100**

Upon successful connection to the camera, the user interface called **Web Configurator** would appear together with the login page. The HTTP port number was not added behind the IP address since the default HTTP port of the camera is 80, which can be omitted from the address for convenience.

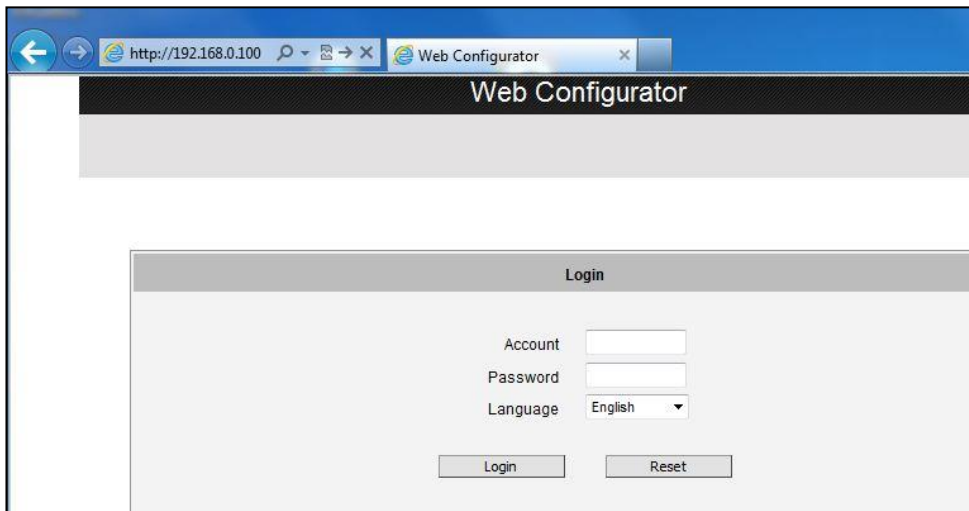

Before logging in, you need to know the factory default Account and Password of the camera.

Account: **Admin**  
Password: **123456**

For further operations, please refer to the **Software User Manual**.